

PSENmag

PSEN 1.1a/b-20



Unit features



- ▶ The actuator **PSEN 1,1-20** belongs to the safety switch
- ▶ Safety switch with cable (5 m/ 10 m)
- ▶ 2 reed contacts (N/O)
- ▶ Assured operating distance: **8 mm**
- ▶ Assured release distance: **26 mm**
- ▶ Square design
- ▶ Works magnetically
- ▶ Switching voltage 24 VDC

Function description

If the actuator is within the response range, the magnets switch the reed contacts on the safety switch. If the actuator is outside the response range (safety gate open), the reed contacts on the safety switch will switch.

Magnetic safety switches for monitoring the position of movable guards in accordance with EN 60947-5-3

Approvals

	PSEN 1.1a/b-20
	◆
	◆

Unit description

The safety switch meets the requirements of EN 60204-1 and IEC 60204-1.

The safety switch only complies with EN 60947-5-3 in conjunction with the actuator **PSEN 1,1-20** and its approved evaluation devices.

The safety switch should only be connected to the evaluation devices listed under "Connections".

Block diagram

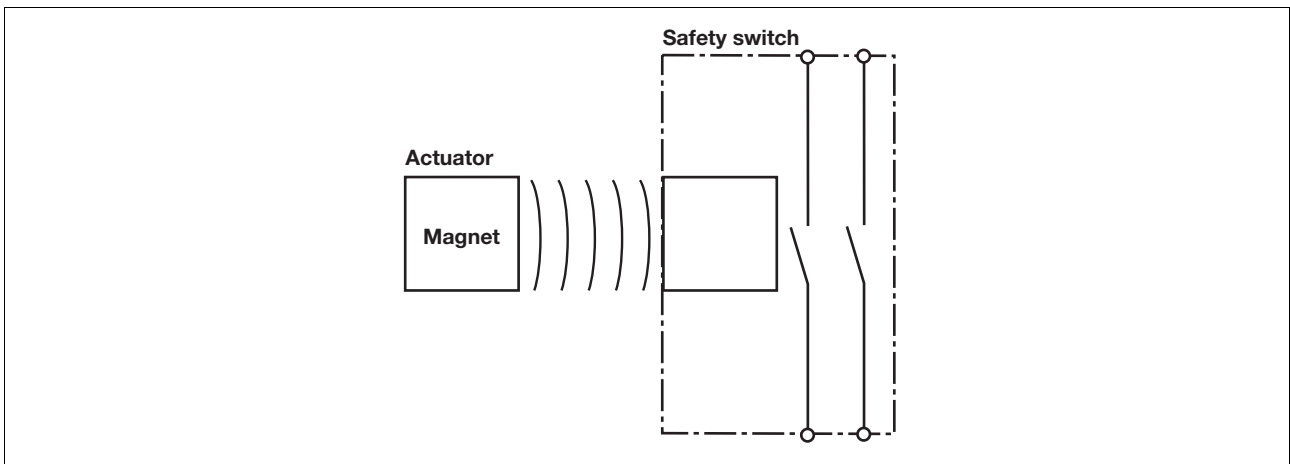

PSENmag

PSEN 1.1a/b-20

Operating distances

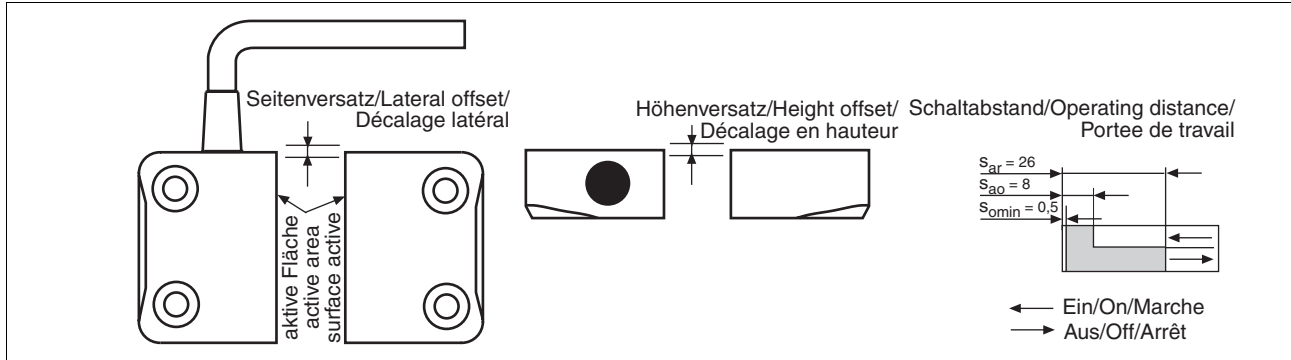

Lateral and vertical offset

- Assured operating distance S_{ao} in mm

		Höhenversatz/Height offset/ Décalage en hauteur				
		1,0	2,0	3,0	4,0	5,0
Seitenversatz/Lateral offset/Décalage latéral	1,0	7,5	7,5	7,0	7,0	5,5
	2,0	7,5	7,0	7,0	6,5	5,5
	3,0	7,0	7,0	7,0	6,0	5,5
	4,0	6,5	6,5	6,0	5,5	5,0
	5,0	6,0	6,0	6,0	5,0	4,5

- Assured release distance S_{ar} :
Max. 26 mm with all vertical and lateral offsets

The stated values are valid at a temperature of 20 °C.

Wiring

Please note:

- Information given in the “Technical details” must be followed.
- Calculation of the max. cable runs I_{max} in the input circuit:

$$I_{max} = \frac{R_{lmax}}{R_l / km}$$

R_{lmax} = max. overall cable resistance (see Technical details)
 R_l / km = cable resistance/km

- When using evaluation devices with delay-on de-energisation contacts, please note:
 - Delay time ≤ 30 s: Delay-on de-energisation contacts satisfy the requirements of category 3 in accordance with EN 954-1 and the requirements of a PDF with single-fault tolerance (PDF-S).
 - Delay time ≥ 30 s: Delay-on de-energisation contacts satisfy the

requirements of Category 1 in accordance with EN 954-1 and the requirements of a PDF with designed reliability (PDF-D).

- In the following commissioning cases, check the function that detects shorts across contacts:
 - On evaluation devices with DC supply voltage: Overall cable resistance ≥ 15 Ohms per channel
 - On evaluation devices with AC supply voltage: Overall cable resistance ≥ 25 Ohms per channel
 - For details of how to perform the test for shorts across the contacts, please refer to the operating manual for the relevant evaluation device.

Connections

The safety switch is shown in an unoperated condition.

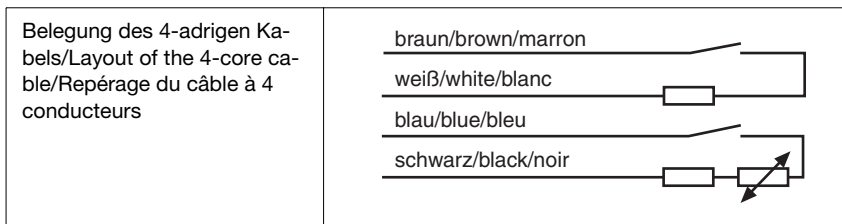

PSENmag
PSEN 1.1a/b-20

► Connection to PNOZ X, PNOZpower, PNOZelog, PNOZsigma

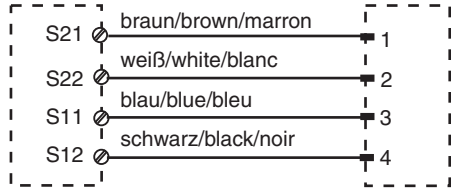
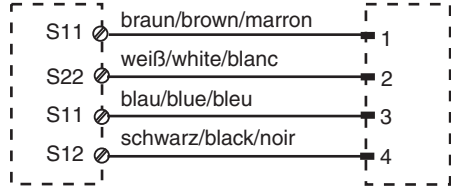
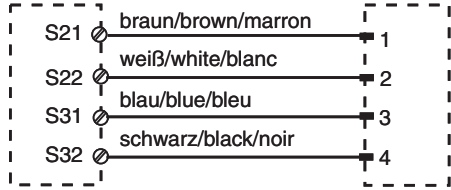
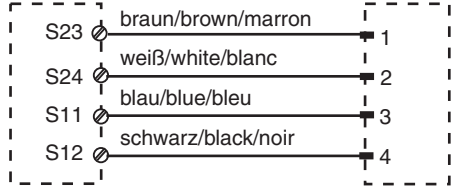
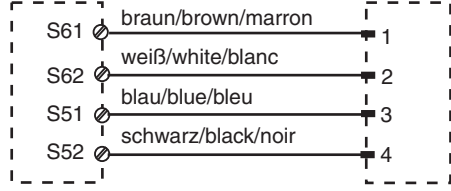
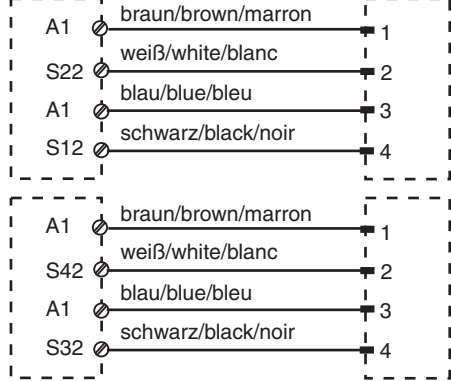
<p>PNOZ p1p PNOZ X2C PNOZ e1p PNOZ p1vp PNOZ X2.1C PNOZ e1.1p PNOZ X2/X2P (nur 24 V DC/ PNOZ X2.1 24 V DC only/ (nur 24 V DC/ 24 V DC only/ 24 V DC seulement) PNOZ X4/X8P PNOZ e6vp PNOZ X2.3P PNOZ X9/X9P PNOZ s3 PNOZ X2.7P PNOZ X10/X10.1 PNOZ s4 PNOZ X2.8P/X2.9P PNOZ X10.11P PNOZ s5 PNOZ Ex</p>	
<p>PNOZ X5 PNOZ X5J</p>	
<p>PNOZ 11 PNOZ X3.1 PNOZ X3.10P PNOZ 16 PNOZ X3P PNOZ XV2 PNOZ X11P PNOZ X2.5P PNOZ XV2P PNOZ X13 PNOZ X3 PNOZ XV3 PNOZ XV3P</p>	
<p>PNOZ X6 (mit Brücke/with link/avec pontage Y3-Y4)</p>	
<p>PMUT X1P</p>	
<p>PNOZ e5.11p</p>	

PSENmag PSEN 1.1a/b-20

▶ Connection to PNOZmulti

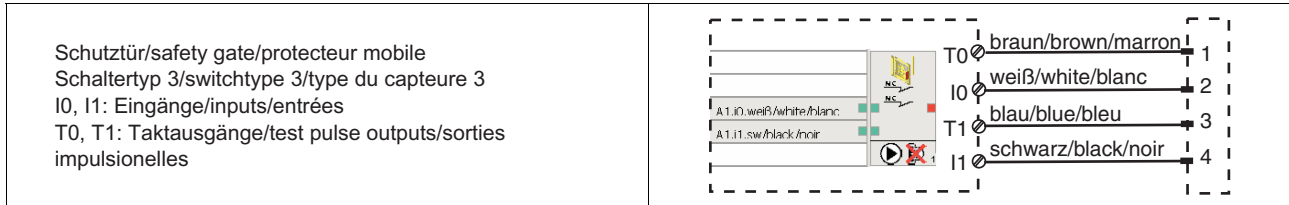

▶ Connection to PSS with and without SafetyBUS p

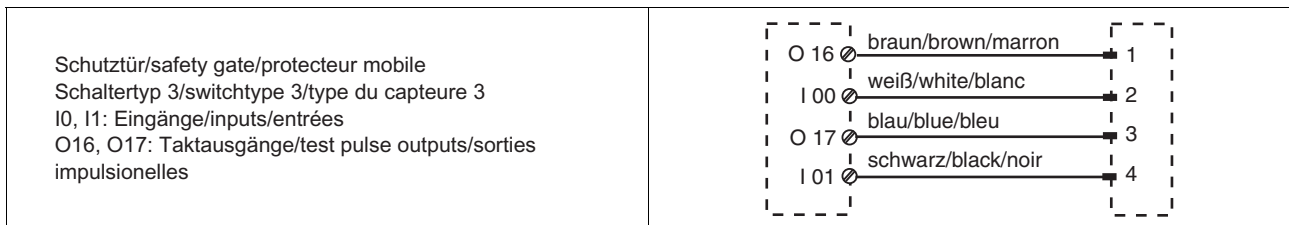

CAUTION!

The safety switches may only be operated on a PSS in conjunction with standard function block SB064 or SB066.

Installation

- ▶ The unit can be installed in any position. However, safety switches and actuators must be positioned opposite each other in parallel:
- ▶ If possible, do not install the safety switch and actuator on to ferromagnetic material. Changes to the operating distances are to be expected. In this case, use the spacer available under order number 534 310.
- ▶ Safety switches and actuators should only be secured using M4 screws with a flat head (e.g. M4 cheese-head or pan head screws). Torque setting max. 1 Nm. Use screws made of non-magnetic material (e.g. Messing).
- ▶ The distance between two systems comprising safety switch and actuator must be at least 25 mm.
- ▶ Safety switch and actuator
 - Keep away from iron swarf
 - Do not expose to strong magnetic fields
 - Do not expose to heavy shock or vibration
 - Do not use as a limit stop

Adjustment

- ▶ The safety switch may only be used with the corresponding actuator **PSEN 1,1-20**.
- ▶ Always test the function with one of the approved evaluation devices.
- ▶ The stated operating distances (see Technical details) only apply when the safety switch and actuator are installed facing each other in parallel. Switching distances may deviate if other arrangements are used. Note the maximum permitted lateral and vertical offset (see "Operating distances" and "Max. lateral and vertical offset").

PSENmag

PSEN 1.1a/b-20

NOTICE

This data sheet is only intended for use during configuration. For installation and operation, please refer to the operating instructions supplied with the unit.

Dimensions

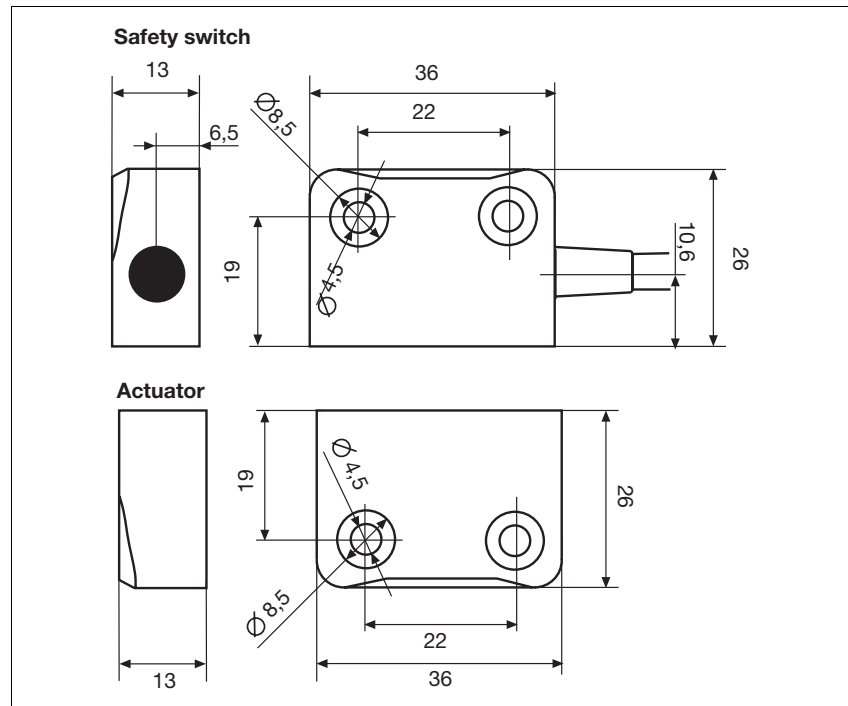

Technical details

Switching distances	
Assured operating distance S_{ao}	8 mm
Min. operating distance S_{omin}	0.5 mm
Assured release distance S_{ar}	26 mm
Switching voltage	24 V
Max. switching current for reed contacts	0.50 A
Max. breaking capacity for reed contacts	10.0 W
Max. switch frequency	1 Hz
Actuator	PSEN 1,1-20
Ambient temperature	-10 - 70 °C
Vibration to EN 60947-5-2	
Frequency	10 - 55 Hz
Amplitude	1.00 mm
Shock stress	30 g , 11 ms
Connection type	10m cable Order no.: 504227 5m cable Order no.: 504226
Cable	LiYY 4 x 0,25 mm²
Protection type	IP69K
Housing material	PBT

PSENmag

PSEN 1.1a/b-20

Technical details	
Dimensions	
Safety switch	
Height	36.0 mm
Width	26.0 mm
Depth	13.0 mm
Actuator	
Height	36 mm
Width	26 mm
Depth	13 mm
Weight	
Safety switch	150 g Order no.: 504226
	320 g Order no.: 504227
Actuator	17 g

The standards current on **2006-12** apply.

Order reference				
Type	Quantity	Operation	Features	Order no.
PSEN 1.1a-20	1/1	magnetic	Safety switch/actuator	504 226
PSEN 1.1a-20 (switch)	1	magnetic	Safety switch	524 126
PSEN 1.1b-20	1/1	magnetic	Safety switch/actuator	504 227
PSEN 1.1b-20 (switch)	1	magnetic	Safety switch	524 127
PSEN 1.1-20	1	magnetic	Actuator	514 120